

# INSTALLATION MANUAL

# 13333

## Level of Difficulty

Easy

Installation difficulty levels are based on time and effort involved and may vary depending on the installer level of expertise, condition of the vehicle and proper tools and equipment.

## Weight Carrying Capacity

Gross trailer weight (GTW)	6,000 lbs.
Tongue weight (TW)	600 lbs.

## Weight Distribution Capacity

Weight distribution (WD)	10,000 lbs.
WD tongue weight (WDTW)	1,000 lbs.

## Parts List

Item	Qty	Description
1	2	Carriage bolt, 1/2"-13 x 1-1/2", grade 8
2	2	Square-hole spacer, 1/4" x 1-1/2" x 3"
3	2	Serrated-flange nut, 1/2"-13
4	2	Fishwire, 1/2" x 30"
5	1	Flat-head socket bolt, 3/4"-10 x 3-1/4", grade 8

## Tools Required

Ratchet	Torque wrench
Socket, 3/4"	Hex bit socket, 1/2"

\* For a tools reference guide visit [curtmfg.com/trailer-hitch-installation](http://curtmfg.com/trailer-hitch-installation)

## ⚠ WARNING

Never exceed the vehicle manufacturer's recommended towing capacity.

## Product Photo



## NOTICE

Visit [www.curtmfg.com](http://www.curtmfg.com) for a full-color copy of this instruction manual, as well as helpful videos, guides and much more!

Before you begin installation, read all instructions thoroughly.

Proper tools will improve the quality of installation and reduce the time required.

This installation requires the use of fishwire to install hardware. No drilling is required.

Periodic inspection of the trailer hitch should be performed to ensure all mounting hardware remains tight and structural components are secure.

To help prevent damage to the product or vehicle, refer to the specified torque specifications when securing hardware during the installation process.

## SAFETY INSTRUCTIONS

Safety glasses should be worn at all times while installing this product.

## Product Registration and Warranty

CURT stands behind our products with industry-leading warranties. To get copies of the product warranties, register your purchase or provide feedback, visit: [warranty.curtgroup.com/surveys](http://warranty.curtgroup.com/surveys)

# ASSEMBLY

## Parts List

Item	Qty	Description
1	2	Carriage bolt, 1/2"-13 x 1-1/2", grade 8
2	2	Square-hole spacer, 1/4" x 1-1/2" x 3"
3	2	Serrated-flange nut, 1/2"-13
4	2	Fishwire, 1/2" x 30"
5	1	Flat-head socket bolt, 3/4"-10 x 3-1/4", grade 8

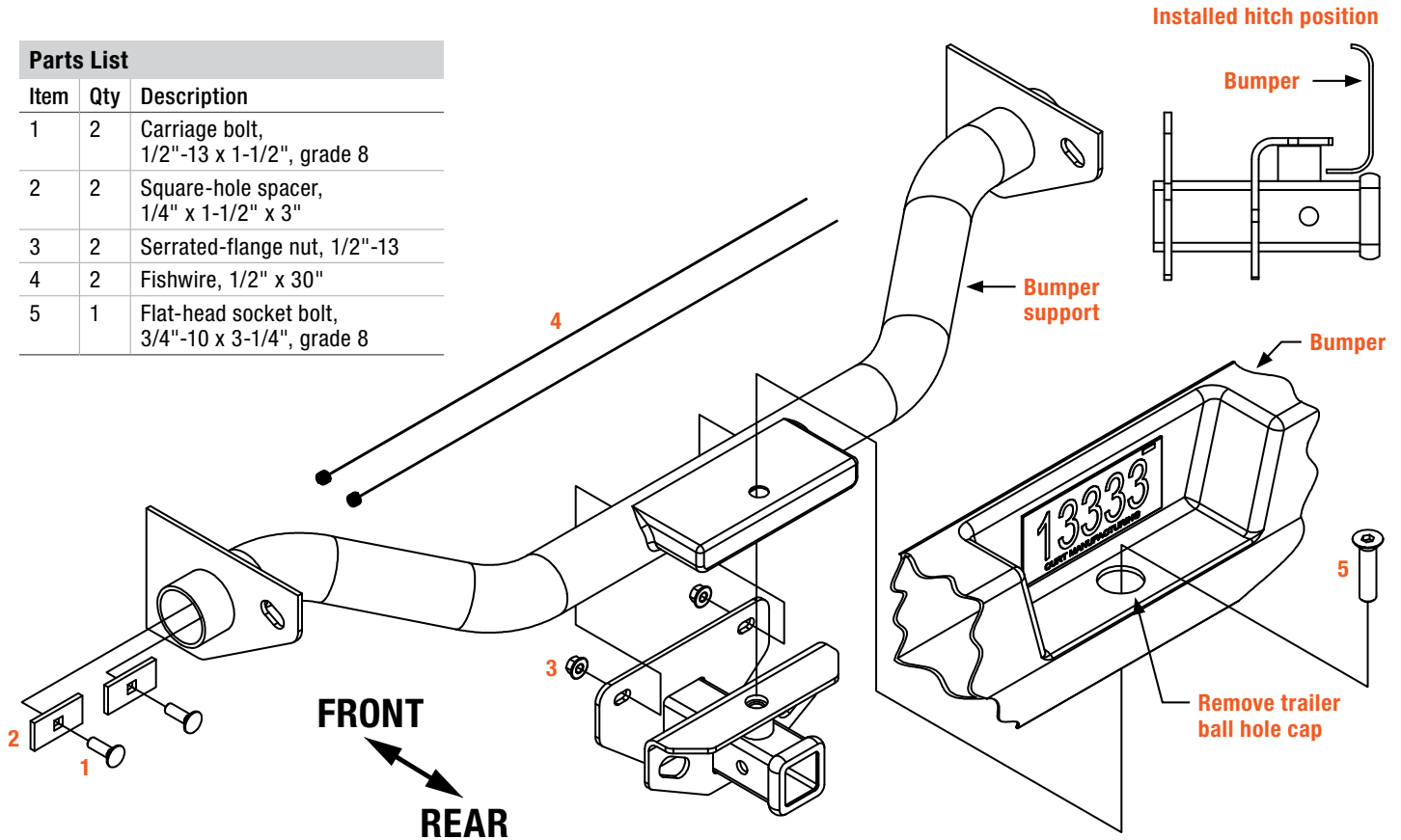

### Step 1

Remove the existing trailer ball hole cap from the center of the bumper and return it to the vehicle owner.

Raise the trailer hitch into position and secure with the provided 3/4" flat-head socket bolt (#5) through the bumper and bumper support into the hitch.

### Step 2

Fishwire (#4) 1/2" carriage bolts (#1) and square-hole spacers (#2) through the end of the bumper support tube and into each mounting hole of the hitch.

### FISHWIRE TECHNIQUE

Insert coiled end of fishwire tool through hitch mounting hole in vehicle frame rail and out the access hole. Pass coiled end of fishwire through spacer and thread bolt into coil. Kink wire to keep spacer separate from bolt as shown. Pull fishwire, spacer and bolt through frame and out mounting hole. Use fishwire to guide hitch during mounting and prevent loss of bolt or spacer inside frame rail.

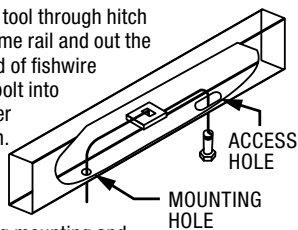

### Step 3

Secure the trailer hitch to the bumper support with 1/2" serrated-flange nuts (#3).

Torque all 1/2" hardware to 110 lb-ft and all 3/4" hardware to 250 lb-ft.

### TOWING BASICS & SAFETY INFORMATION

For information on safely towing your trailer, visit [curtmfg.com/understanding-towing](http://curtmfg.com/understanding-towing).